

Article number: 0105027

Description: Retaining ring AV 12

Note: Fitted with ZGA pliers

Measures

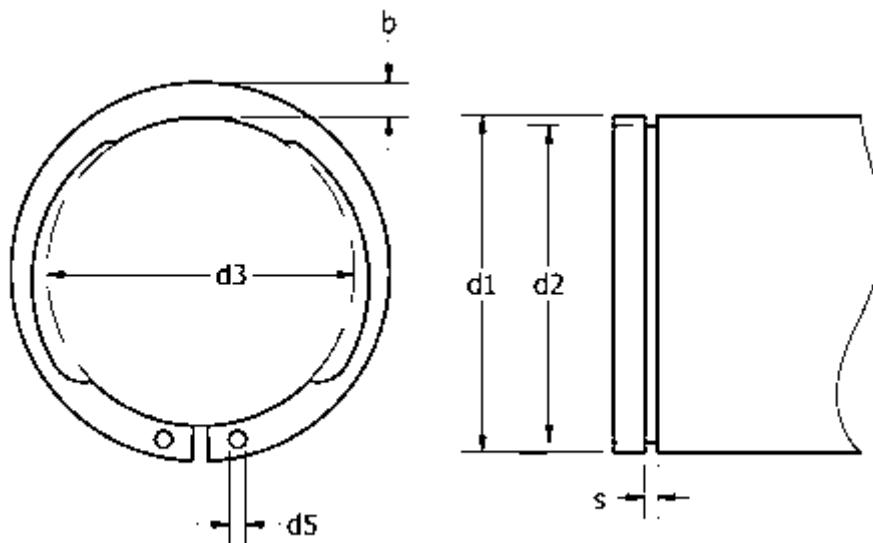

AN mm ²	= 4.2	FRg kN	= 2.4	t	= 0.25
b	= 2.1	FR kN	= 4.5	tol	= -0.06
d1	= 12	g	= 1.0	tol	= -0.11
d2	= 11.5	K kN-mm	= 21.6	tol	= +0,10-0,36
d3	= 11.00	m min	= 1.10	tol	= 0.1
d5 min	= 1.3	n abl x 1000	= 79	Tong	= ZGA-0
Description	= AV 12	s	= 1.00	Weight kg/1000	= 0.50
FN kN	= 0.70	Side power N at I2	= 0.7		